

ROUGH COUNTRY

SUSPENSION SYSTEMS®

07-UP TAHOE/YUKON/SUB 7.5" KIT

Thank you for choosing Rough Country for your suspension needs. We appreciate your business!!

▲ NOTICE This kit will not fit vehicles equipped with electric steering or trucks with factory auto leveling or auto ride systems.

Important note: Please refer to the instructions on the last page for trimming the tie rods. For alignment purposes, it will be necessary to trim/shorten the tie rod end to allow the front end alignment to be set properly.

Rough Country recommends a certified technician install this system. In addition to these instructions, professional knowledge of disassemble/reassembly procedures as well as post installation checks must be known. Attempts to install this system without this knowledge and expertise may jeopardize the integrity and/or operating safety of the vehicle.

Please read instructions before beginning installation. Check the kit hardware. Be sure you have all needed parts and know where they go.

PRODUCT USE INFORMATION

▲ WARNING As a general rule, the taller a vehicle is, the easier it will roll. Seat belts and shoulder harnesses should be worn at all times. Avoid situations where a side rollover may occur. Generally, braking performance and capability are decreased when larger/heavier tires and wheels are used. Take this into consideration while driving. Do not add, alter, or fabricate any factory or after-market parts to increase vehicle height over the intended height of the Rough Country product purchased. Mixing component brands is not recommended.

Rough Country makes no claims regarding lifting devices and excludes any and all implied claims. We will not be responsible for any product that is altered. We will be happy to answer any questions concerning the design, function, and correct use of our products.

This kit is packaged as a leveling kit—raising the front 7 1/2" and the rear 6".

Due to differences in manufacturing, dimension and inflated measurements, tire and wheel combinations should be test fit prior to installation. For this application we recommend a 18" or larger wheel not to exceed 9" in width. When using a 18" wheel backspacing should be maximum of 5.5" and a minimum 5.0". With a 20" or larger wheel backspacing should be a maximum of 6.0" and a min of 5.5". Additionally a quality tire of radial design is recommended, not exceeding 35" tall and 12.5" wide. Please note that use of a 35" x 12.5" tire may require modification to the front valance.

Optional kicker Bars Part #1262 are available for this kit. Please contact you local Rough Country Dealer for information.

NOTICE TO DEALER AND VEHICLE OWNER

▲ WARNING Any vehicle equipped with any Rough Country product should have a "Warning to Driver" decal installed on the inside of the windshield or on the vehicle's dash. The decal should act as a constant reminder for whoever is operating the vehicle of its unique handling characteristics.

INSTALLING DEALER - it is your responsibility to install the warning decal and forward these installation instructions on to the vehicle owner for review. These instructions should be kept in the vehicle for its service life.

We hope installing your Rough Country lift kit is a positive experience. Please note that variations in construction and assembly in the vehicle manufacturing process will virtually ensure that some parts may seem difficult to install. Additionally, the current trend in manufacturing of vehicles results in a frame that is highly flexible and may shift slightly on disassembly prior to installation. The use of pry bars and tapered punches for alignment is considered normal and usually does not indicate a faulty product. However, if you are uncertain about some aspect of the installation process, please feel free to call our tech support department at 800-222-7023. We do not recommend that you modify the Rough Country parts in any way as this will void any warranty expressed or implied.



KIT COMPONENTS



1264Box1

Front Cross Member
Rear Cross Member

1264Box3

Driver Knuckle
Pass Knuckle

1209Box1

Front Strut Spacers
Driver Diff Bracket
Pass Diff Bracket
Skid Plate
Sway Bar Drop Bracket
CV Spacers
Front Brake Line Brackets
3/8 Stud Bag
1264Bag1
1264Bag2

1209Box2

Rear Coil Spring
Bump Stops
Driver Rear Shock Bracket
Pass Rear Shock Bracket
Sway Bar Links
Track Bar Bracket
Brake Line Bracket
1280Bag1

1286Box1

Coil spring spacer
Spacer washer
1286Bag1

This kit is packaged in 5 boxes. Please confirm that you have all the needed parts and know where they go prior to beginning installation.

Front Cross Member

5/8" X 4 1/2" Bolt (2)
5/8" Nuts (2)
5/8" Flat Washers (4)

Rear Cross Member

5/8" x 5 1/2" Bolt (2)
5/8" Lock Nuts (2)
5/8" Flat Washers (4)

Front CV Axle Spacers

10mm x 65mm SHCS Bolt (12)

Driver Side Diff. Drop Bracket

12mm x 35mm Bolt (2)
12mm Flange Nut (2)
12mm Washer (2)

Pass Side Differential Brkt

12mm x 45mm Bolt (2)
12mm Flange Nut (2)
12mm Washer (2)

Lower Strut to Ctrl Arm Mt

10mm x 55mm Bolt (4)
10mm Lock Nuts (4)
10mm Washers (8)

Sway Bar Bracket

10mm x 35mm Bolt (4)
10mm Lock Nuts (4)
10mm Lock Washer (4)
10mm Washers (8)

Frnt & Rr Brake Line Brackets

5/16" x 3/4" Bolt (4)
5/16" Nylon Lock Nut (4)
5/16" Washer (8)

Skid Plate Installation

3/8" x 1" Bolt (4)
3/8" Lock Washer (4)
3/8" Flat Washer (4)

Rear Spring Spacer

3/8" x 3 3/4" Bolt (2)
3/8" Flangelock
Spring Spacer Washers

Rear Shock Brackets

5/8" x 1.5" Bolt (2)
5/8" Lock Nut (2)
5/8" Washers (4)

14mm x 75mm Bolts (2)

14mm Nylocks (2)

14mm Washers (4)

Rear Sway Bar Links

12mm x 65mm Bolts (2)
12mm Flangelocks (2)

12mm Washers (2)

Sleeves (4)

Brake Line Bracket

5/16" x 1 1/4" Bolt
5/16" Flange Lock Nut

Track Bar Bracket

Sleeve .562 x .750 x 1.75
9/16" x 3 1/2" Bolt
9/16" Lock Nut
9/16" Washer (2)
7/16" x 1" Bolt (2)
7/16" Nylock (2)
7/16" Washers (4)

Rear Bump Stops

3/8" x 1" Self Tapping Bolt (4)

Rear Coil Spacers

3/8" x 2.25" Bolts (2)
3/8" Flange Nuts (2)

CAD DRAWING SHOWING KIT COMPONENTS AND INSTALLED LOCATIONS

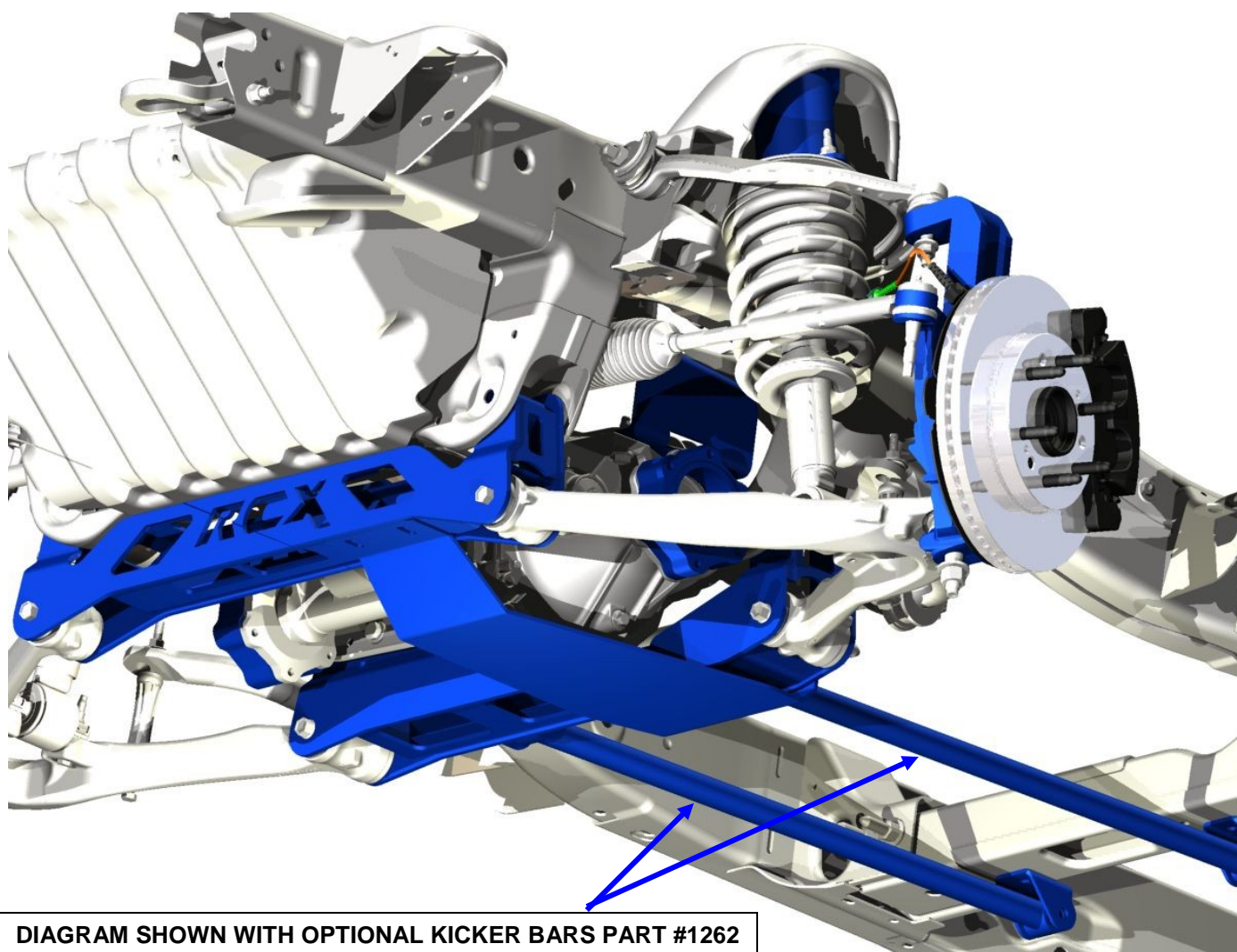

DIAGRAM SHOWN WITH OPTIONAL KICKER BARS PART #1262 INSTALLED

Torque Specs:

Size	Grade 5	Grade 8
5/16"	15 ft/lbs	20 ft/lbs
3/8"	30 ft/lbs	35 ft/lbs
7/16"	45 ft/lbs	60 ft/lbs
1/2"	65 ft/lbs	90 ft/lbs
9/16"	95 ft/lbs	130 ft/lbs
5/8"	135 ft/lbs	175 ft/lbs
3/4"	185 ft/lbs	280 ft/lbs
	Class 8.8	Class 10.9
6MM	5 ft/lbs	9 ft/lbs
8MM	18ft/lbs	23 ft/lbs
10MM	32ft/lbs	45ft/lbs
12MM	55ft/lbs	75ft/lbs
14MM	85ft/lbs	120ft/lbs
16MM	130ft/lbs	165ft/lbs
18MM	170ft/lbs	240ft/lbs

Tools Needed:

Floor Jack /Jack Stands
 8mm Allen Socket
 10mm socket /wrench
 11mm socket /wrench
 13 mm socket/wrench
 15mm socket / wrench
 17mm socket/wrench
 18mm socket /wrench
 21mm socket /wrench
 22mm socket /wrench
 24mm socket /wrench
 19mm socket /wrench
 35mm socket
 9/16 socket /wrench
 Torsion bar Tool
 Reciprocating Saw
 Drill
 11/16" Drill Bit
 Hand Grinder
 Thread Locker

FRONT INSTALLATION

1. Park the vehicle on a level surface and chock the rear wheels.
2. Jack up the front of the vehicle. Place jack stands under the frame rails and lower onto jack stands letting the front suspension hang.
3. Remove the tires and wheels. Remove the upper and lower factory skid plates using a 15mm wrench. Retain factory hardware and front skid plate for reuse.
4. Using a 21mm wrench, remove the tie-rod nut as shown in **Photo 1**. Strike the side of the mount to dislodge the tie rod end. Remove from the knuckle.
5. Remove the sensor wire from the plastic clip. Remove the bracket from the control arm using a 10mm wrench. See **Photo 2**.

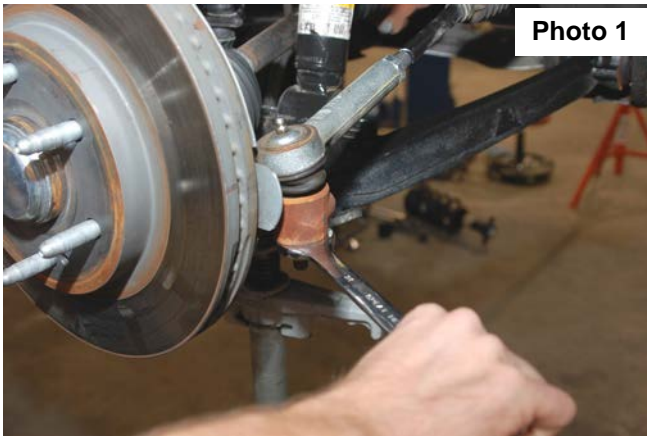

6. Remove and unplug the ABS sensor wire from the frame as shown in **Photo 3** and remove the two bolts holding brake caliper to the factory knuckle using a 18mm wrench. Remove the caliper assembly from the knuckle and hang securely out of the way. Do not hang the caliper by the brake hose.
7. Remove the axle nut from the knuckle as shown in **Photo 4** using a 35mm socket. Retain the hardware for reuse.

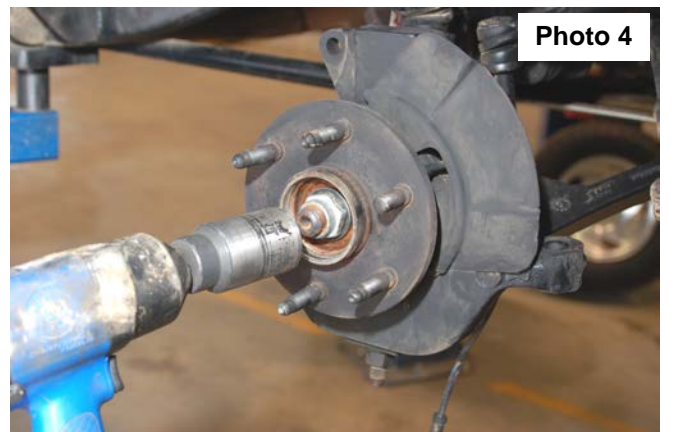

8. Using a 18mm wrench, remove the upper strut nuts as shown in **Photo 5**. Retain factory hardware for reuse.
9. Using a 15mm wrench, remove the 2 bolts securing the lower strut as shown in **Photo 6**, to the lower control arm and remove the strut from the vehicle. Remove and discard the factory lower retainer clips. New hardware will be used.

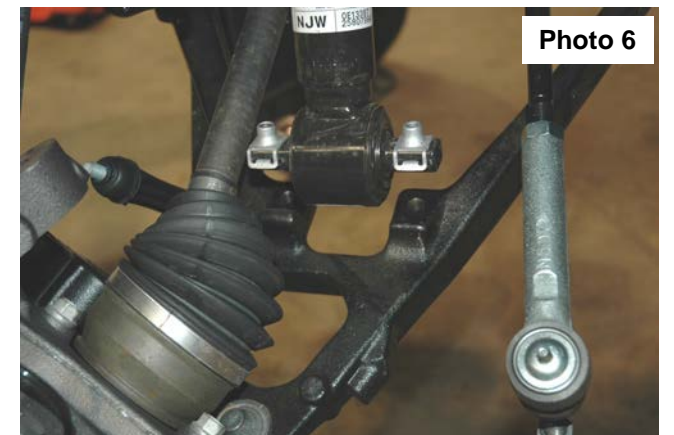

10. Remove the sway bar & end links from the lower control arm as shown in **Photo 7** using a 15mm wrench.
11. Remove the sway bar from the frame as shown in **Photo 8** using a 10mm wrench. Retain all hardware for reuse.



12. Using a 15mm wrench, remove the 6 axle shaft bolts from the differential and remove from the knuckle. Repeat on opposite side.
13. Remove the upper and lower ball joint from knuckle using a 18mm wrench and 24mm on the lower. Upper shown in **Photo 9**. Strike the knuckle as shown to dislodge the ball joint. Separate the upper control and lower control arm from the knuckle and remove the knuckle and the lower control arms from the vehicle.
14. Mark location of alignment cams on upper control arms to allow reinstallation of stock arm to the same position. Using a 21mm wrench and 21mm socket, remove the upper control arms from the vehicle. **See Photo 10**. Retain the hardware for reuse.



15. Cut the bump stop from the upper control arm mount on the passenger and driver side as shown in **Photo 11** using a reciprocating saw. **Passenger side shown.**
16. After the bump stop has been cut from the control arm mount, grind and apply paint to the cut surface to prevent rusting. **See Photo 12**. Reinstall the factory control arm in the factory location using the factory hardware. Tighten using a 21mm Socket / wrench. Be sure to use the marks made earlier for alignment reference.

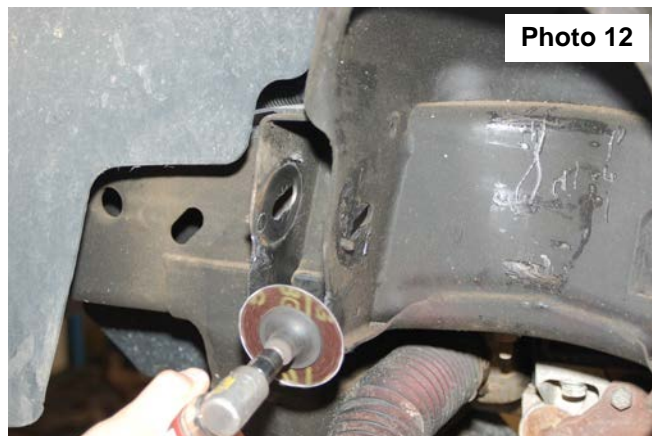
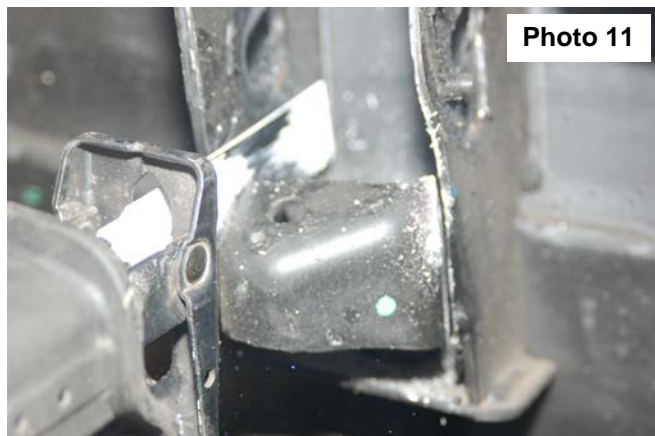

17. Make an alignment mark to show relationship between driveshaft and differential input flange. Using a 11mm wrench, remove the four drive shaft bolts. **See Photo 13.** Retain hardware for reuse.
18. Place a floor jack under the differential assembly to provide support for following steps.
19. Unplug the electrical connector on differential as shown in **Photo 14.**



Photo 13

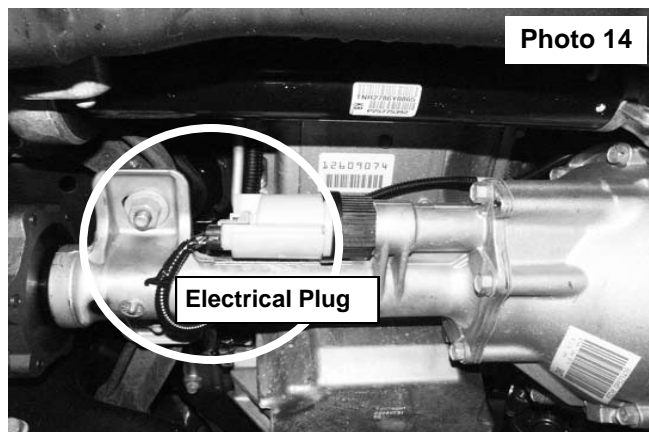

Photo 14

20. Unplug the differential vent hose shown in **Photo 15.**
21. Remove the four rear cross member bolts and remove the rear cross member brace as shown in **Photo 16** using a 18mm wrench.

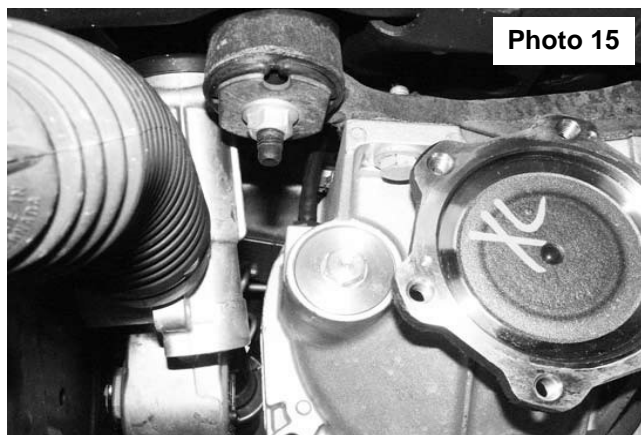

Photo 15



Photo 16

22. Using a 18mm socket remove the 4 differential bolts (2 each side) securing the differential to the frame. **See Photo 17.** Retain the hardware for reuse.
23. Slowly lower differential assembly to the ground.
24. Trim the lower control arm mount on the frame as shown in **Photo 18.** Trim only enough to allow for installation of new front RCX cross member.



Photo 17

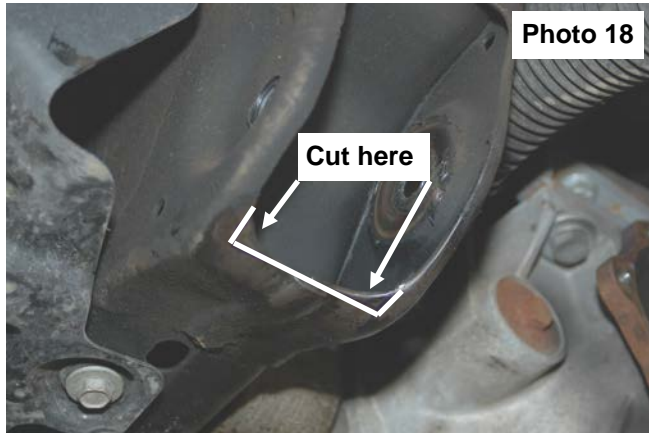

Photo 18

25. Install the front cross member as shown in **Photo 19** with the supplied 5/8" x 4 1/2" bolts, nuts /washers. Do not tighten at this time.
26. On the drivers side rear lower control arm pocket, measure over 3/4" from the edge of the hole on the rear frame where the cross member was removed in step 10 and mark area to be cut as shown in **Photo 20**. Please note the area needs to be cleaned of any oil, grease and/or undercoating. These coatings can be flammable.



Photo 19



Photo 20

27. Cut area with reciprocating saw as shown in **Photo 21** and remove. Be sure to cut all the way through front to back.
28. After the cross member has been trimmed, grind the edges smooth using a hand grinder, and apply paint to raw metal.
29. Install the Passenger differential drop bracket (open side to center of truck) with the supplied 12mm flange nuts. **See Photo 22.**

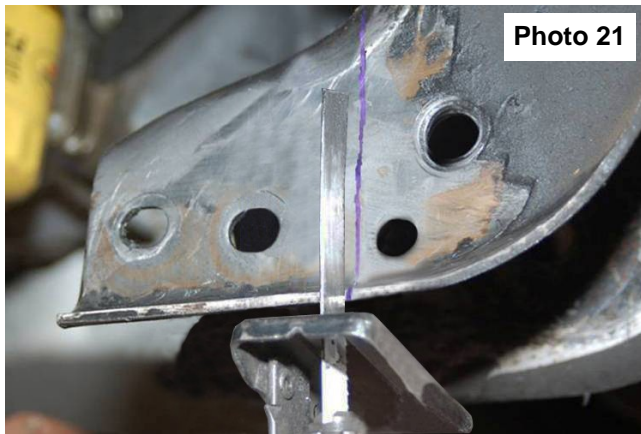

Photo 21

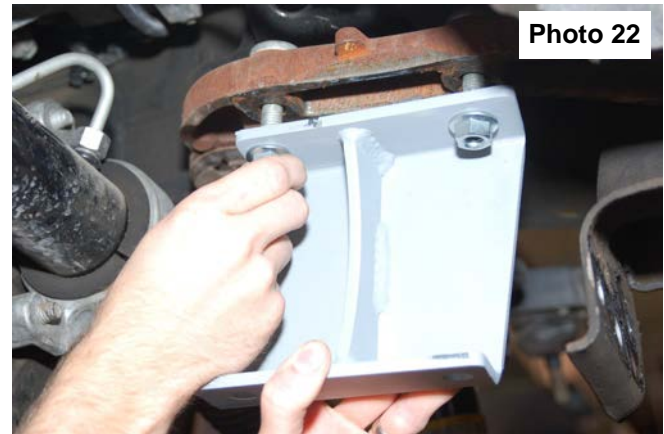

Photo 22

30. Install the Driver side differential drop bracket (open side to center of truck) with the notch at the bottom to allow clearance for the differential axle shaft flange using the supplied 12mm x 35mm bolts & washers. Do not tighten.
31. Raise the differential back into place and install on the drivers side drop brackets with the supplied 12mm flange nut and the factory bolts. **See Photo 23.**
32. Install the differential to the passenger side drop brackets with the factory nuts and the supplied 12mm x 45mm bolts & washer on the head of the bolt. **The stock nuts/ large washers must be reused to make sure the differential stays located in the drop bracket.**
33. Tighten the diff drop brackets (65ft. lbs) to the frame and the differential to the diff drop brackets using a 18mm wrench .
34. Install the rear cross member in the factory location using the supplied 5/8" x 5 1/2' bolts, nuts/ washers as shown in **Photo 24.**

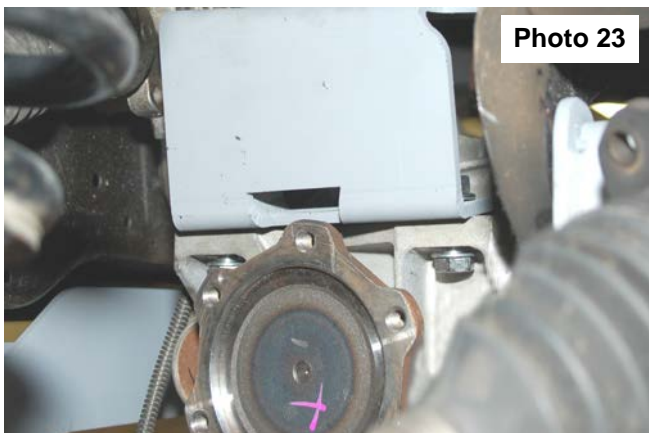
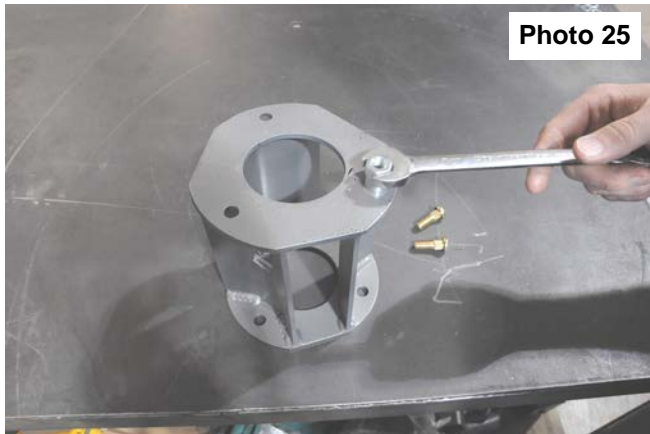

Photo 23

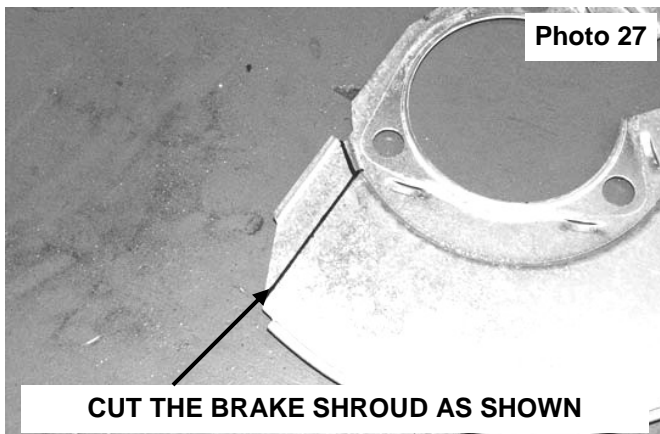

Photo 24

35. Reinstall the lower control arms in the cross member brackets with the factory hardware. Do not tighten at this time.
36. Using a 17mm wrench and the supplied sleeve and nut, press in the 10mm studs into the strut spacer. **See Photo 25.**
37. Install the strut spacer on top of the factory strut as shown in **Photo 26** with the stock hardware. Tighten using a 18mm wrench.



38. Install the strut in the upper strut tower using the supplied 10mm nuts, washers & lock washers. Tighten using a 17mm wrench.
39. Install the lower part of the strut in the factory location on the lower control arm with the supplied 10mm x 55mm bolts, nuts /washers. Tighten using a 17mm wrench.
40. The brake shroud must be trimmed to allow the caliper to be reinstalled, Mark the dust shroud as shown in **Photo 27** and trim. Reinstall the brake caliper on the knuckle with the factory hardware and tighten.
41. On the factory knuckles, remove the bearing assembly using a 15mm wrench and install in the new knuckle. Tighten hardware. **See Photo 28.**



42. Install the knuckles on the lower ball joint with the factory hardware. Tighten using a 18mm wrench
43. Position the axle shafts in the knuckle and tighten the factory nut using a 35mm socket. Torque to 155 ft-lbs.
44. Install the CV axle spacer as shown in **Photo 29** between the axle shaft and the differential. Secure with the supplied 10mm x 65mm allen head bolts using 8mm allen socket. Use Loctite on the bolt threads and torque to 45ft. Lbs using a crossing pattern.



45. Trim tie rod ends as per instructions on last page and install on the knuckle. Tighten using a 21mm wrench.
46. Install the sway bar drop brackets with the 10mm x 35mm bolts, lock washers, and flat washers using a 17mm wrench. Tighten hardware. **See Photo 30.**
47. Install the sway bar on the sway bar drop brackets with the stock bolts and supplied 10mm nuts & washers. Tighten using a 17mm wrench. **See Photo 31.**

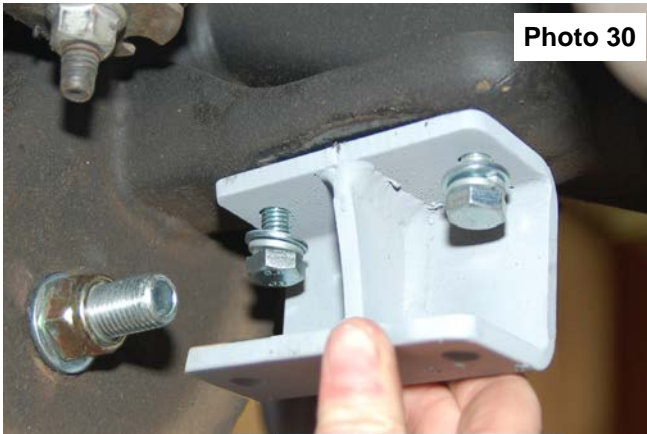

Photo 30



Photo 31

48. Reinstall the drive shaft on the differential with the stock hardware using a 11mm wrench. Note clocking marked during disassembly.
49. Install the skid plate as shown in **Photo 32** with the supplied four 3/8" x 1" bolts, flat washers and lock washers on the front and rear cross member. Tighten using a 9/16 wrench.
50. Using the supplied template on last page of instructions as a guide, mark and drill the lower control arm using a 11/16" drill bit to relocate the sway bar end link. **See Photo 33.** After drilling, install the sway bar end link with the stock hardware and tighten.



Photo 32

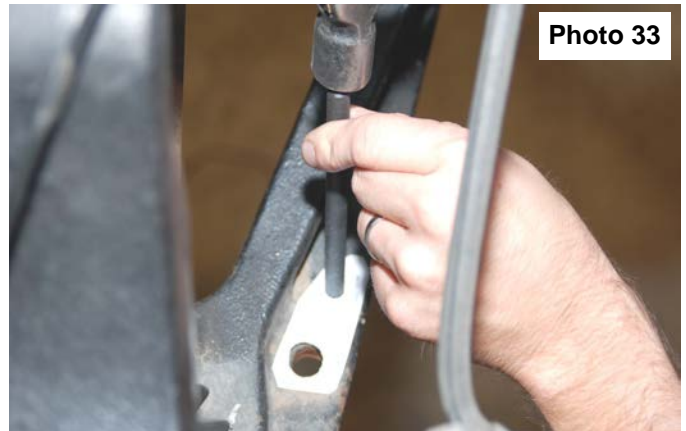

Photo 33

51. Slightly pull down on the diff vent hose and reinstall on the differential. **See Photo 34.** It may be necessary to loosen the diff vent hose from the wire loom to allow for enough slack to reconnect to the axle.
52. Reconnect the electrical connection on the axle that was removed in Step 16.
53. Remove the brake line bracket from the upper control arm mount as shown in **Photo 35** using a 13mm wrench.

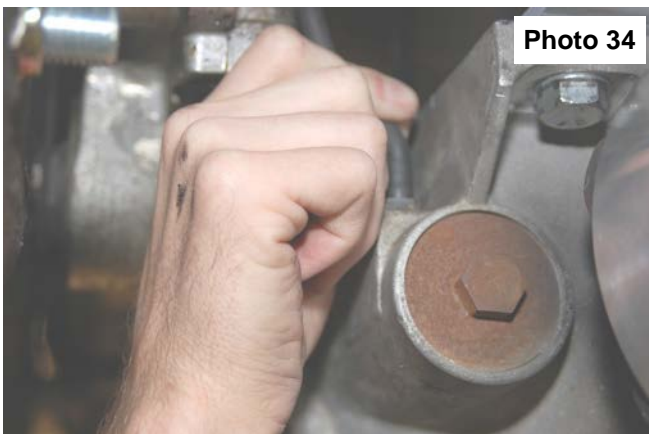
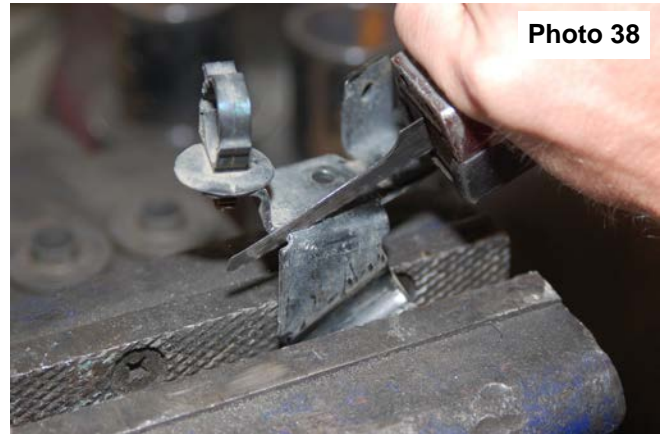
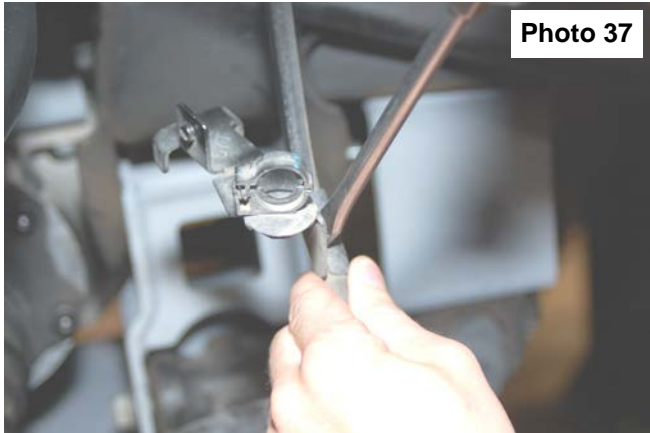

Photo 34



Photo 35

54. Install the supplied brake line relocation bracket on the upper control arm mount with the stock hardware. Slightly pull down on the brake line assembly and reinstall on the drop bracket with the supplied 5/16" x 3/4" bolts, nuts /washers using a 7/16 wrench. **See Photo 36.** Reconnect the ABS wire that was disconnected in Step 6.
55. Remove the ABS wire from the brake line clip and remove the brake line from the bracket using a flat head screw driver as shown in **Photo 37** and trim as shown in **Photo 38**. Reinstall the modified bracket on the stock control arm with the stock hardware and reinstall the ABS wire in the clip.
56. If the optional kicker bars were purchased with this kit, install at this time per the instructions included with that kit.
57. Reinstall the factory upper skid plate with the factory hardware.
58. Install the tires and wheels. Jack up the front of the vehicle and remove the jack stands.
59. Lower the vehicle to the ground.



REAR INSTALLATION INSTRUCTIONS

1. Chock the front wheels and jack up the rear of the vehicle. Support the vehicle with jack stands.
2. Remove the tires/wheels using 7/8" deep well socket.
3. Lightly support the axle with a floor jack.
4. Using a flat head screwdriver, remove the e-brake line from the track rod by removing the clip as shown in **Photo 1**.
5. Remove the track rod from the axle as shown in **Photo 2** using a 21mm socket/wrench.

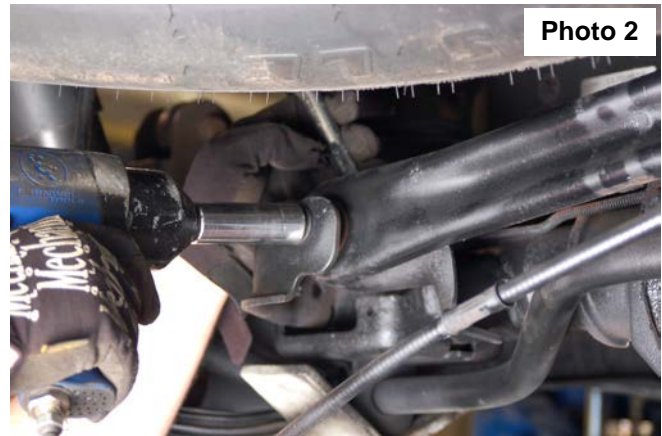
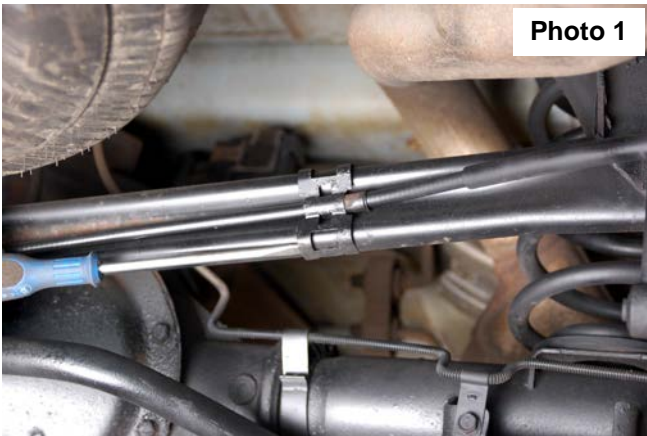

6. Remove the bolt securing the brake line bracket using a 13mm socket as shown in **Photo 3**. Retain hardware for reuse.
7. Remove the sway bar links from the axle and the frame using a 18mm wrench as shown in **Photo 4**. Retain the upper frame mount hardware for reuse.

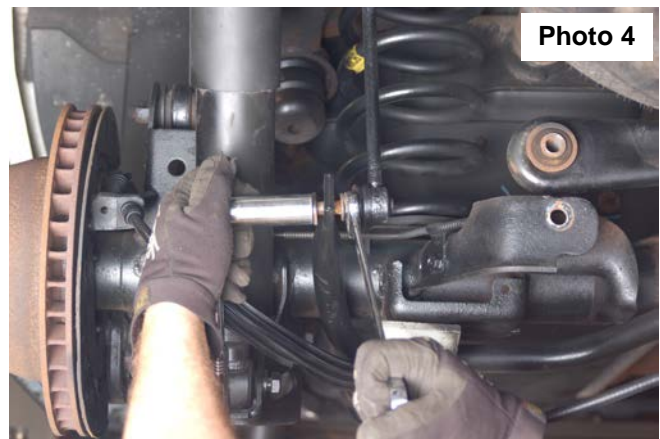

8. Remove the lower shock from the axle as shown in **Photo 5** using a 21mm wrench/socket leaving the upper part of the shock attached to the frame. Retain the hardware for reuse.
9. Remove the lower control arm from the axle using a 21mm wrench/socket. Retain hardware for reuse.
10. Lower the axle with the floor jack and remove the coil springs.
11. Install the rear coil spring spacer using the spacer washer on the top of the spring pocket with the spacer on the bottom side. Insert the 3/8" x 2.25" bolt and secure with a 3/8" flange nut. Tighten with a 9/16" socket and wrench. **See Photo 6**

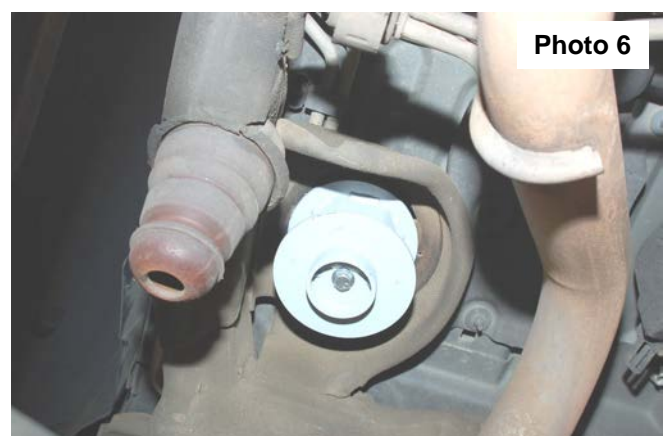
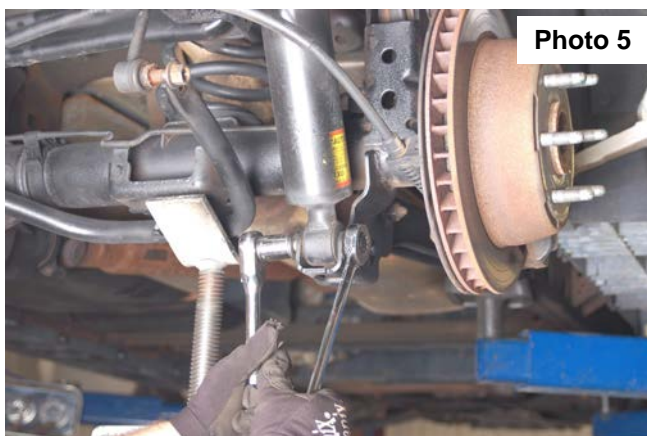

12. Install the new coil springs in the stock location. Reinstall the lower control arms on the axle with the stock hardware and tighten using a 21mm wrench/socket.
13. Install the new track bar bracket as shown in **Photo 7** in the stock location with the supplied crush sleeve and stock hardware with flanged nut towards middle of vehicle. Do not tighten at this time.
14. Make sure the bracket is square as shown in **Photo 8**. Mark and drill the two holes using a 15/32" drill bit.

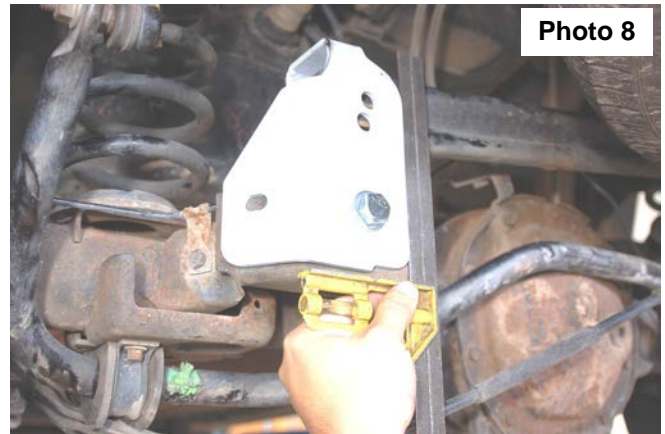
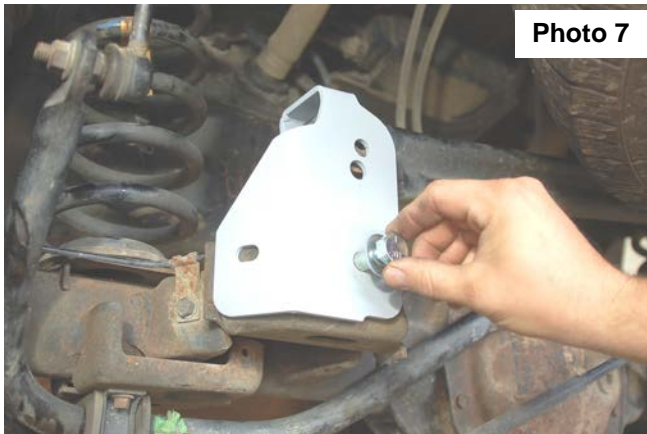

15. Secure with the supplied 7/16" x 1" bolts, washers /nuts as shown in **Photo 9**. Raise the axle to align the track rod with the new bracket and install using supplied 9/16" x 3 1/2" bolt, washers, and nut into the top hole of the track bar bracket. Tighten using a 21mm socket & 22mm wrench. Tighten 7/16" bolts to 52 ft. lbs and the 9/16" bolt to 82 ft. lbs.
16. Install the lower shock relocation bracket (**Please note there is a passenger and driver side bracket**) in the stock location as shown in **Photo 10** using the 1/2" X 1 1/4" bolts, washers & nuts in the lower rear hole and the supplied 9/16" x 3 1/2" bolts, washers, and nuts in the stock location. Tighten 1/2" bolt to 57 ft-lbs. and the 9/16" bolt to 82 ft-lbs. The stock shocks will be installed after the vehicle is lowered to the ground using stock hardware.
17. Install the bump stops as shown aligning the new bump stop bracket with the factory bump stop. Mark and drill the



17. Install the bump stops as shown aligning the new bump stop bracket with the factory bump stop. Mark and drill the holes using a 11/32" drill bit as shown in **Photo 11**.
18. Install the bump stops with the supplied 3/8" x 1" self tapping bolts using a 9/16" socket. Do not over-tighten. See **Photo 12**.

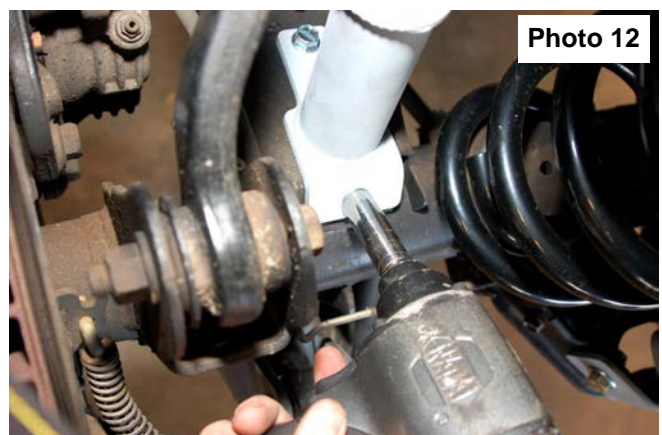
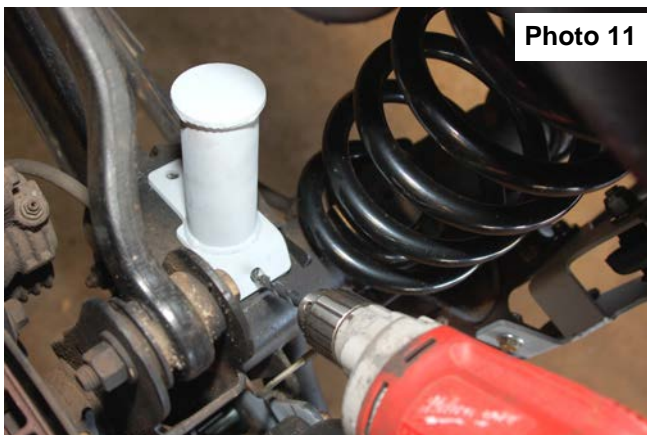

19. Remove the brake line from the brake line bracket using a 1/2" wrench. **See Photo 13.**
20. Install the new brake line bracket as shown in the stock location on the differential with stock hardware using a 13mm wrench. **See Photo 14.**



Photo 13



Photo 14

21. Install the brake line on the new brake line extension bracket as shown in **Photo 15** with supplied 5/16" x 1 1/4" bolt, washer & nut.
22. Swing the sway bar up and install the supplied rear links as shown in **Photo 16** with supplied 1/2" x 2 1/2" bolts/washers & nuts in lower mount and stock hardware in upper mounts. Tighten to 57 ft. lbs.

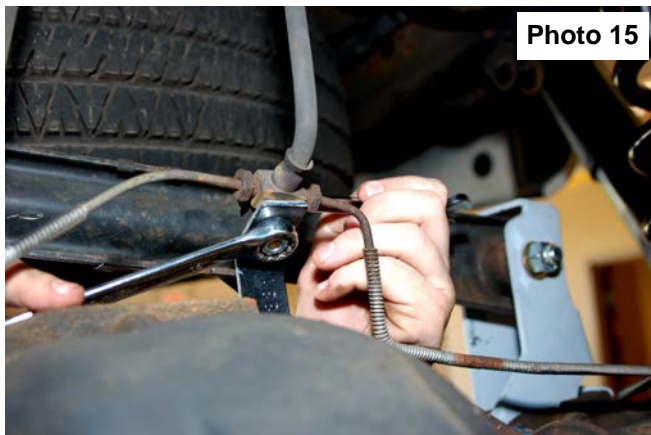

Photo 15



Photo 16

23. Install the wheels and tires.
24. Jack up the vehicle and remove the jack stands. Lower the vehicle to the ground.
25. Install the stock shocks in the new mounts with the stock hardware using a 21mm wrench. Tighten to factory specifications.

BUMPSTOP MODIFICATION

1. Remove the bump stop from the stock location on the frame. Trim the bump stop as shown in **Photo 17** using a reciprocating saw. This bump stop modification is only on certain models with 4 ring bump stops.
2. Only the top portion will be trimmed as shown in **Photo 18**. After the bump stop has been trimmed, reinstall on the vehicle in the stock location.

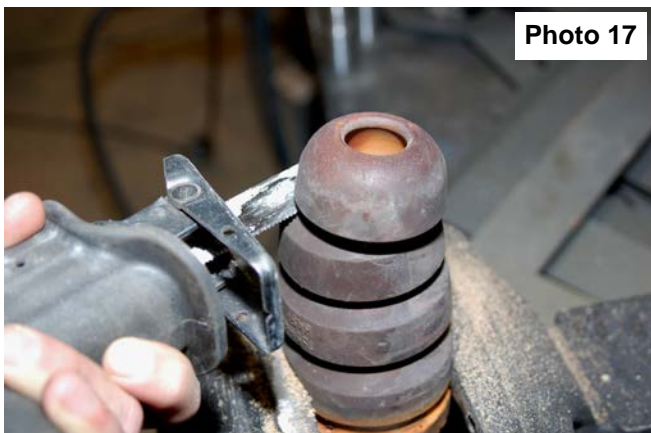

Photo 17



Photo 18

TEMPLATE FOR SWAY BAR RELOCATION

Cut out template and position template on lower control arm as shown in Step 45. Drill with a 11/16 drill bit and relocate the sway bar end links into the new location.

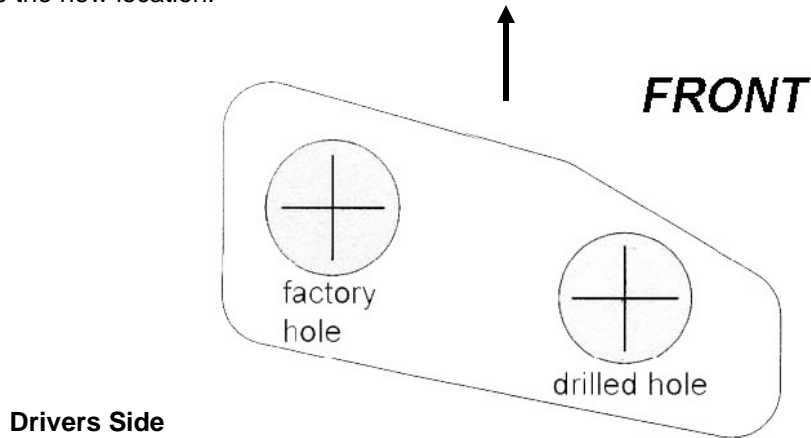

INSTRUCTIONS FOR TRIMMING TIE ROD ENDS.

1. Disassemble the tie rod from the tie rod ends
2. Measure over 3/8" and mark.
3. Cut the tie rods / tie rod sleeves as shown below to allow the vehicle to be realigned.
4. Smooth any rough edges.
5. Reassemble the cut assembly



POST INSTALLATION INSTRUCTIONS

1. Check all fasteners for proper torque. Check to ensure for adequate clearance between all rotating, mobile, fixed, and heated members. Verify clearance between exhaust and brake lines, fuel lines, fuel tank, floor boards and wiring harness. Check steering gear for clearance. Test and inspect brake system.
2. Perform steering sweep to ensure front brake hoses have adequate slack and do not contact any rotating, mobile or heated members. Inspect rear brake hoses at full extension for adequate slack. Failure to perform hose check/ replacement may result in component failure.
3. On some vehicles the front lower skirting will need to be trimmed if using certain wheel /tire combinations and with heavy offset wheels. Trim only as needed.
4. Activate four wheel drive system and check front hubs for engagement.
5. Have a qualified alignment center align the vehicle immediately. Realign to factory specifications. The following are the recommended specifications:

Caster in degrees	4.5 +-1.0
Camber in degrees	0.0—.3
Toe In in degrees	0.1 +- .2

Important note: For alignment purposes, please refer to the instructions above. The inner & outer tie rod ends may need to be trimmed to allow the front end alignment to be set properly. Please alert your alignment specialist of this possibility.

6. Perform head light check and adjustment to proper settings.
7. Check and retighten wheels at 50 miles and again at 500 miles.
8. All kit components must be retightened at 500 miles and then every three thousand miles after installation. Periodically check all hardware for tightness.
9. Install "Warning to Driver" decal on sun visor

Note: Installation of larger tires will require speedometer recalibration.

Thank you for choosing Rough Country for all of your suspension needs.

**ROUGH
COUNTRY**
SUSPENSION SYSTEMS