

SIMPLY SUPERIOR.

2.5" & 3.5" J-KRAWL SUSPENSION SYSTEM

**2007-2018 JEEP JK WRANGLER
2 & 4 DOOR MODELS**

JSPEC2354

www.jksmfg.com | jks@ridefox.com | 517-278-1226

RV. 110821

GETTING STARTED

Read all warnings, instructions, notes and cautions before you begin the installation.

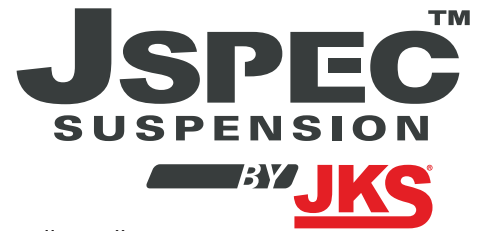

WHO SHOULD INSTALL THIS?

We recommend that this system be installed by a professional mechanic. The installer will need professional knowledge of special tools required for installation as well as assembly and disassembly procedures.

STAYING SAFE AND LEGAL

- If you fail to drive your lifted and modified vehicle safely it may result in serious injury or death.
- Exercise caution: A lifted vehicle is at greater risk for rollovers or loss of control, especially during abrupt maneuvers.
- Always wear your seat belt, reduce your speed and avoid sharp turns.
- Never operate your vehicle under the influence of drugs or alcohol.
- Consult local and state laws for the legality of your ride height.

BEFORE YOU BEGIN INSTALLATION

- Needed items: OE service manual for your vehicle, safety glasses, and any special tools as indicated in these instructions as well as the following tools: assorted metric and standard wrenches, hammer, hydraulic floor jack and a set of jack stands.
- Ride Height: Measure the initial ride height of your vehicle prior to installation. Final ride height may vary depending on the factory height of your vehicle.
- Tires and rims: Larger tire and rim combinations can increase leverage and cause additional stress to suspension, steering, and related components. When installing larger than OE tires and rims, the following components should be inspected for wear every 2500-5000 miles: ball joints, tie rod ends, wheel bearings, track bar bushings, pitman arm.
- Drive line vibrations: Some vehicles may experience drive line vibration after installation of this suspension system. Possible remedies for this include: tuning angles, replacement of slider on shaft, lengthening or truing of shaft, and/or replacing u-joints.
- Installation without a hoist: We recommend completing the rear alterations first if no hoist is available.



TRACTION CONTROL COMPLIANT

In an effort to reduce the risk of rollover crashes the National Highway Traffic Safety Administration (NHTSA) established the Federal Motor Vehicle Safety Standard (FMVSS) No. 126 requiring all new passenger vehicles under 10,000 lbs GVWR include an electronic stability control (ESC) system as standard equipment. Effective August 2012 this law requires aftermarket products to be compliant with these same standards.

VISIT 560PLUS.COM FOR MORE INFORMATION!

THANK YOU FOR CHOOSING JSPEC SUSPENSION

TIRE FITMENT

2.5" LIFT

33x12.50 on 16x8 with 4.5" backspacing

3.5" LIFT

35x12.50 on 16x8 with 4.5" backspacing

SPECIAL TOOLS REQUIRED

Torque Wrench

5/16" Drill (Bump Stop Extensions)

INSTALLATION TIME



Approximately 6-7 hours

BEFORE YOU BEGIN

2012-18 models using the stock front driveshaft will require exhaust extension kit JKS8150.

01. PRE-INSTALLATION

- Measure from the center of the wheel up to the bottom edge of the wheel opening.

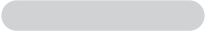
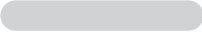
	Drv	Pass
Front		
Rear		

02. REAR DISASSEMBLY

- Disconnect the track bar at the axle with the vehicle still on the ground using a 21mm socket. Save bolt and nut tab.
- Raise and support the vehicle with jack stands positioned in front of the lower suspension arm brackets. Remove the tires.
- Remove the parking brake cable bracket (10mm) [1]. Save nuts.
- Remove the bolts holding the brake lines to the frame (10mm) [2].

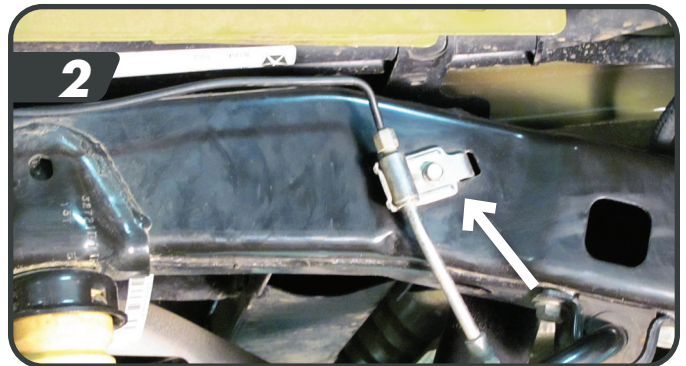
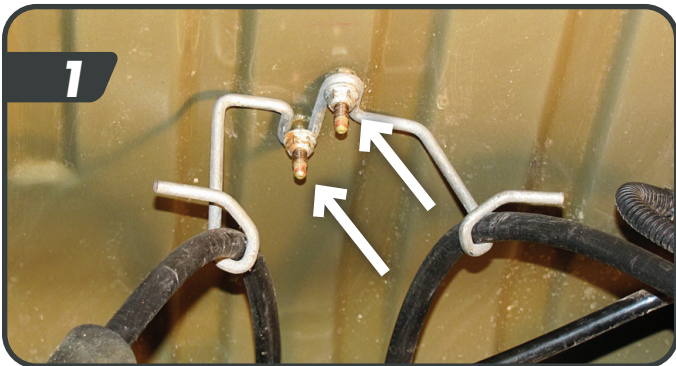

- e. Using some side cutters pry the wheel speed sensor wiring from the bottom of the frame to gain additional slack [3].
- f. Support the axle with a jack under the center of the differential and remove the shocks from the frame (16mm) and axle (18mm), save hardware [4].

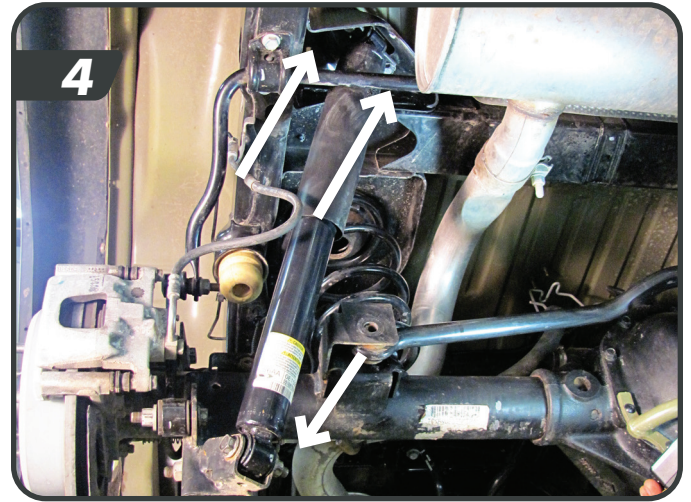
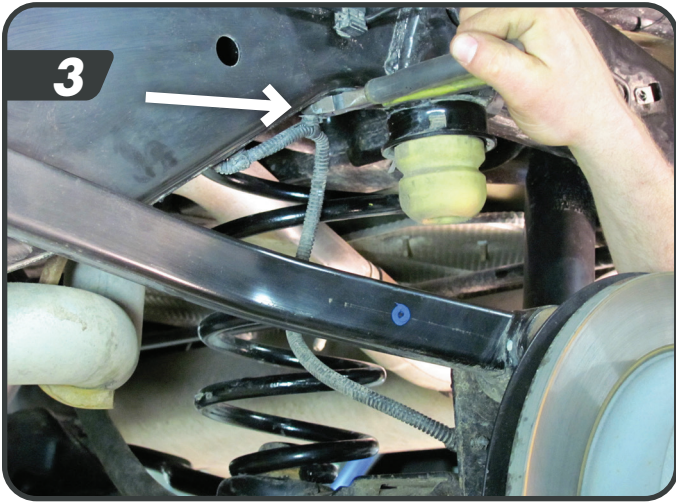

- g. Rubicon models: Disconnect the locker wires from the differential.
- h. Remove the sway bar links from the axle and save hardware (18mm) [5].

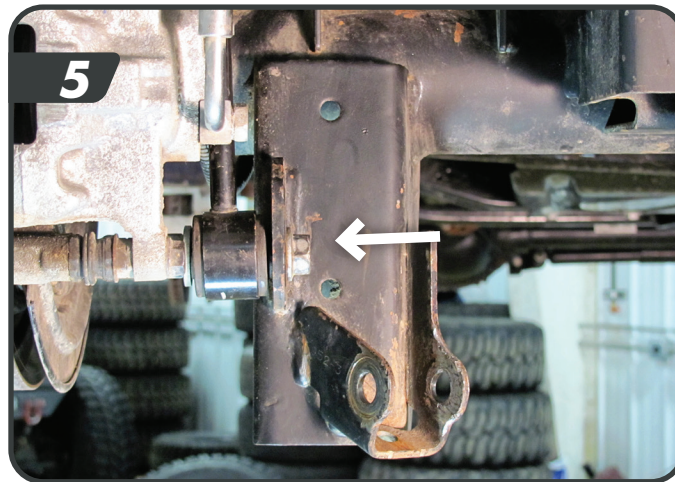

- i. Lower the axle enough to remove the factory springs. Make sure there is adequate slack on all wires.

03. REAR INSTALLATION

J-FLEX REAR CONTROL ARMS

Perform replacement control arm installation one side at a time.

- a. Raise the axle housing back into position and support with a hydraulic jack.
HINT: The axle housing should be evenly supported and the suspension at normal ride height. Do not attempt removal or installation with the suspension extended, or the axle drooped, as this will place tension on suspension arm mounting hardware.
- b. Remove the lower suspension arm bolt and nut from the axle housing bracket. Retain the original mounting hardware.
- c. Remove the bolt and flag nut from the chassis rail bracket. Retain the original mounting hardware.
- d. Remove the original lower suspension arm from the vehicle. [6]



- e. Set the length of the lower control arms.
 - Determine the correct length for your application using factors such as:
 - Pinion Angle
 - Tire Clearance
 - Factory length is 19-³/₄"
 - Max. length is 21-¹/₂"
 - Set both control arms to the same length. Lengthening the lower arms will reduce pinion angle.
- f. Apply anti-seize lubricant to bolt threads of original mounting hardware.

- g. Mount the rubber bushing end of the control arm to the axle housing bracket. [7] Install the original mounting bolt and finger tighten the nut. DO NOT torque mounting hardware until instructed.



- h. Mount the control arm to the frame bracket with the grease fitting up. Install the original mounting bolt and flag nut. Finger tighten the bolt. DO NOT torque mounting hardware until instructed.

HINT: If mounting bolt is difficult to install due to misalignment of the control arm bushing with mounting bracket, either (1) adjust height of axle housing with hydraulic jack, or (2) move axle housing into position with a heavy-duty ratchet strap.

- i. Repeat installation steps on opposite side of vehicle, then continue on to the upper arms.
j. Remove the upper suspension arm bolt and nut from the axle housing bracket. Retain the original mounting hardware.
k. Remove the bolt and flag nut from the chassis rail bracket. Retain the original mounting hardware.
l. Remove the original upper suspension arm from the vehicle. [8]

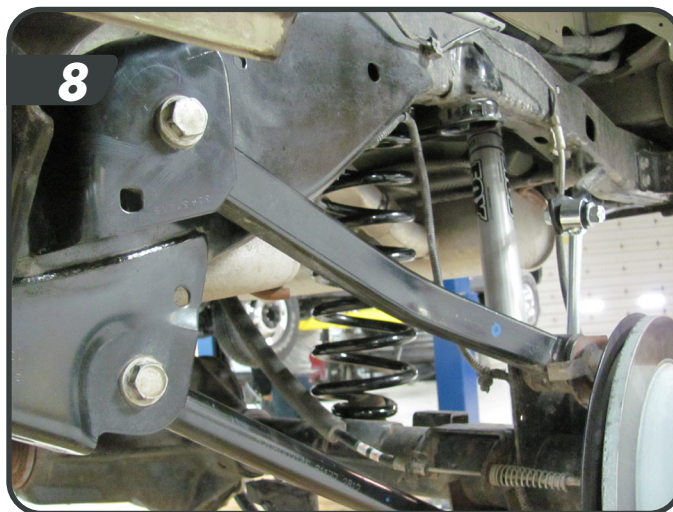

- m. Set the length of the upper control arms.
- Determine the correct length for your application using factors such as:
 - Pinion Angle
 - Tire Clearance
 - Factory length is 17-1/2"
 - Max. length is 19"
 - Set both control arms to the same length. Lengthening the upper arms will increase pinion angle.
- n. Apply anti-seize lubricant to bolt threads of original mounting hardware.

- o. **Establish control arm orientation.** The arms should be mounted so that the bend goes inward (away from the tire) and the rubber bushing end mounts to the axle. [9]

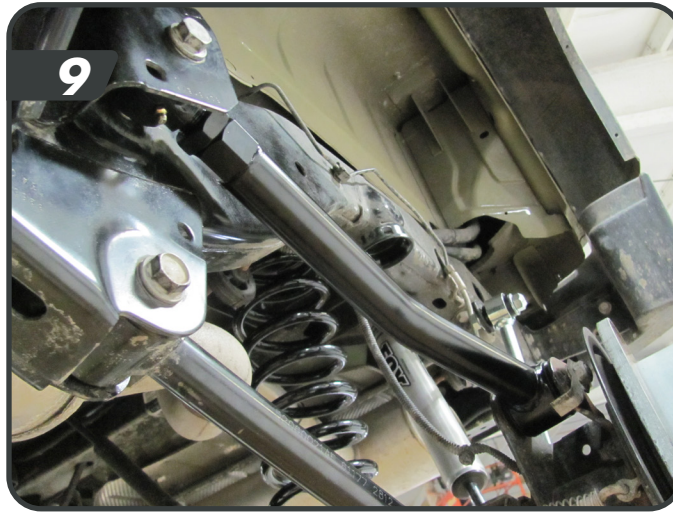

- p. Mount the rubber bushing end of the control arm to the axle housing bracket. Install the original mounting bolt and finger tighten the nut. DO NOT torque mounting hardware until instructed.
- q. Mount the control arm to the frame bracket with the grease fitting down. Install the original mounting bolt and flag nut. Finger tighten the bolt.
- r. Repeat installation of upper arm on opposite side of vehicle. All rear control arm bolts will be torqued when the full weight of the vehicle is on the ground.

COIL SPRINGS, SWAY BAR LINKS, BUMP STOPS

Rear Bump stop spacers 03574, 03575 will require bolt pack J106

- s. Install the shorter pair of JSPEC coils springs into the rear of the vehicle with the orientation as shown. Raise the axle to compress the springs enough to hold it in place [10].
- t. The rear sway bar link axle mounts will need to be drilled to accommodate the added lift. Measure up 1-1/4" from the center of the OE mounting hole and drill a 1/2" hole at the mark. Paint bare metal. [11]



u. Re-install sway bar links into the drilled hole. [12]

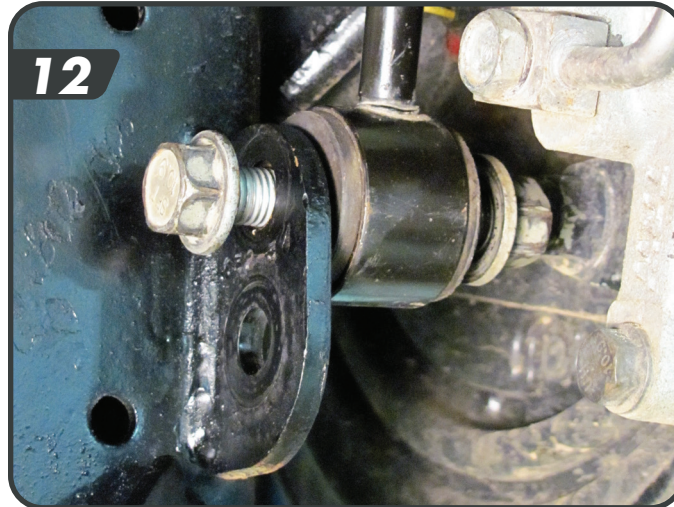

v. Install the rear bump stop spacers on the axle with the 2" tall orientation for 2.5" lifts and 3" orientation for 3.5" lifts. In both cases the bump should be installed with the offset in material forward. Fasten the bump stop spacer to the axle with the 5/16" x 7/8" bolts, nuts and washers. Torque bolts to 20 ft-lbs. (1/2") [13]

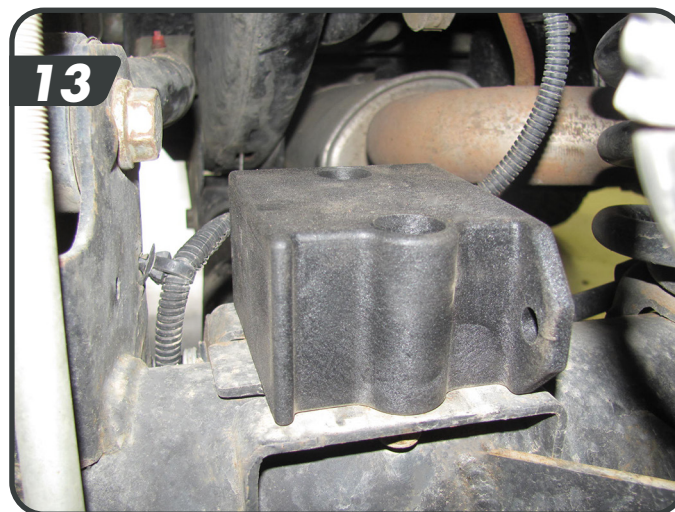

w. Install the shocks into the vehicle with the factory hardware.

REAR BRAKE LINES & TRACK BAR BRACKET

Rear track bar bracket 03179 and riser brace 03217 will require bolt pack J103

Brake line brackets 03172 and 03173 will require bolt pack 768

- x. Position the rear track bar bracket on the axle above the factory bracket so radius edges rest on the axle tube and the rear track bar mount hole aligns with the hole in the bracket.
- y. Install the riser brace into the factory pocket using the factory track bar bolt and nut tab, do not tighten. [14B
- z. Install (2) 3/8" x 1" bolts and washers from the inside of the track bar bracket and through the riser brace. Fasten with provided nuts and washers.
 - aa. Install the u-bolt, washers, and nylock nuts and fasten the relocation bracket to the axle tube.
 - ab. Tighten the u-bolt hardware to 65 ft-lbs; the original track bar bolt to 125 ft-lbs; and the 3/8" hardware to 40 ft-lbs [14A]. The track bar will be re-installed with the vehicle on the ground.

Note: The unused hole on the track bar bracket is only used when the JKS Rear Trackbar brace OGS169 has been installed.
 - ac. Attach the brake line drop brackets to the brake line so the brake line tab fits in the drop bracket slot using the provided 1/4" hardware.
 - ad. Attach the brackets to the frame using the factory hardware [15]. Re-install only the lower clip for the ABS wire.
 - ae. Rubicon models: Reattach the locker wire harness to the differential.
 - af. Reattach the parking brake cable bracket to the floor using the factory nuts.
 - ag. Mount the tires and lower the vehicle to the ground.
 - ah. Install the rear track bar into the relocation bracket with the provide 9/16" x 3" bolt, nut, and washers.

Tip: Use an assistant to push on the body of the vehicle to help align the track bar in the bracket.
 - ai. Torque the track bar bolts to 110 ft-lbs.

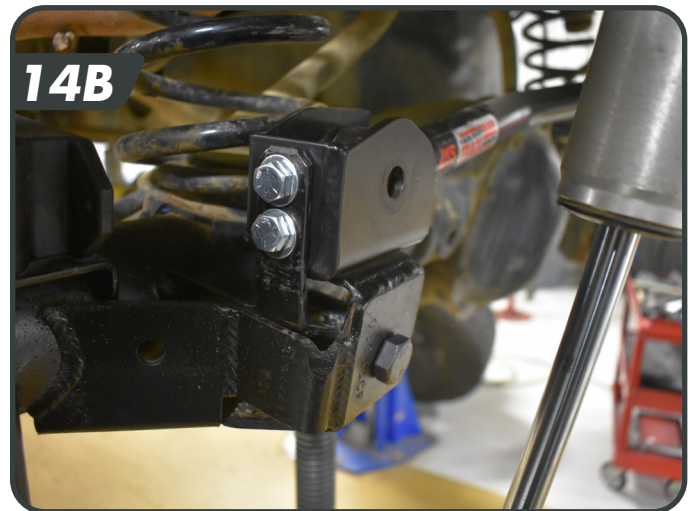
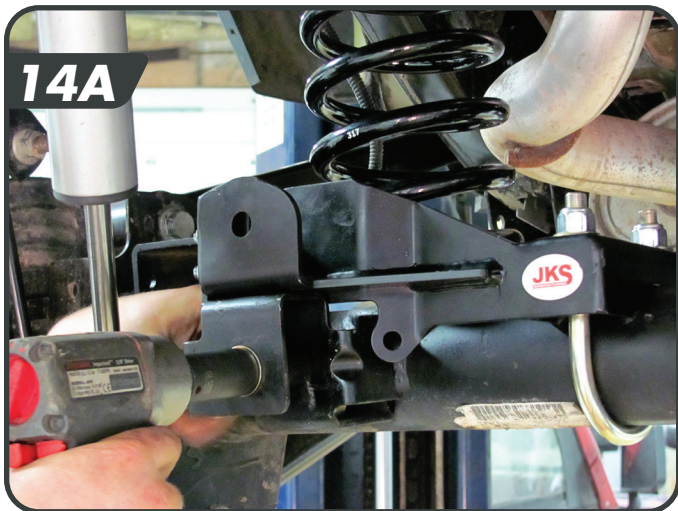



04. FRONT DISASSEMBLY

- a. Disconnect the front track bar (21mm) from the axle. Save bolt and nut tab.
- b. Raise the vehicle and support the frame with jack stands behind the front lower control arm pockets.
- c. Remove the wheels.
- d. Disconnect the front brake line brackets from the frame rails (10mm). 2011-18 models: Disconnect the brakelines from the axle below the coil spring. Save hardware.
- e. Rubicon models: Disconnect the front locker wires from the differential.
- f. Disconnect the sway bar links from the axle (18mm) and sway bar. Discard links and hardware. [16]
- g. Remove the 4 bolts mounting the front driveshaft to the pinion flange (15mm). This is done to ensure the driveshaft does not bind when installing the new springs. [17]

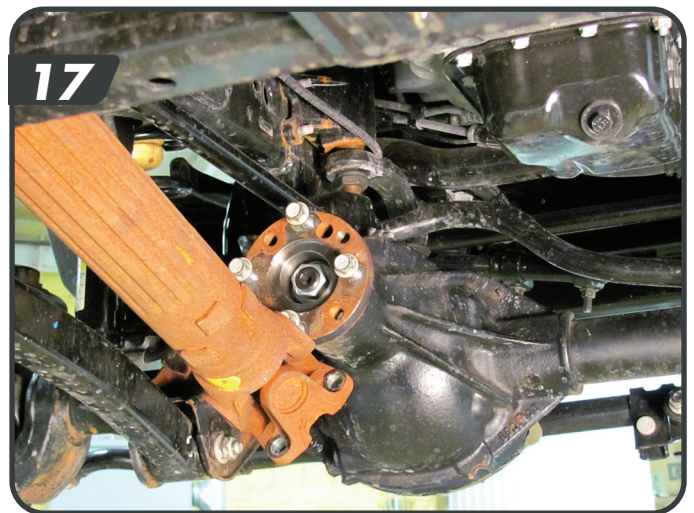
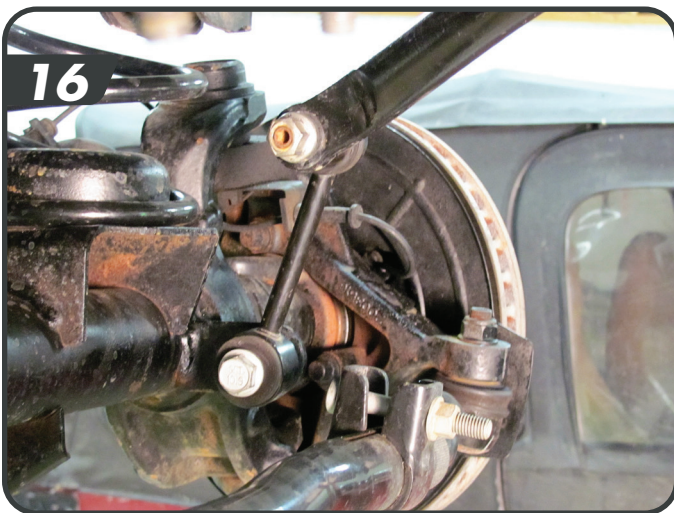

- h. Disconnect the steering drag link from the pitman arm to ensure it doesn't bind when installing the new coil springs. Remove the tie rod end nut and dislodge the tie rod end from the pitman arm. Save nut. [18]



- i. Support the front axle with a hydraulic jack. Remove the front shocks from the vehicle using a 16mm wrench for the top and 18mm on the bottom. Save lower hardware.
- j. Lower the front axle and remove the coil springs. As the axle is lowered, verify all brake and electrical wires have enough slack and the driveshaft clears the pinion flange.

05. FRONT INSTALLATION

J-FLEX FRONT CONTROL ARMS

Perform replacement control arm installation one side at a time.

- a. Raise the front axle housing back into position and support with a hydraulic jack.
HINT: The axle housing should be evenly supported and the suspension at normal ride height. Do not attempt removal or installation with the suspension extended, or the axle drooped, as this will place tension on suspension arm mounting hardware.
- b. Remove the lower suspension arm bolt and nut from the axle housing bracket. Retain the original mounting hardware.
- c. Remove the bolt and nut from the chassis rail bracket. Retain the original mounting hardware.
- d. Remove the original lower suspension arm from the vehicle. [19]



- e. Set the lower control arm length.
 - Determine the ideal arm length for your application by considering factors such as:

- Tire Clearance
- Steering Clearance
- Pinion Angle / Caster
- Factory length is 22-5/8"
- Max. length is 24 3/8"

○ **Set both control arms to the same length.** Lengthening the arms will increase caster and reduce pinion angle.

- f. Apply anti-seize lubricant to bolt threads of original mounting hardware.
- g. **Establish control arm orientation.** The arms should be mounted so that the bend goes inward (away from the tire) and the rubber bushing end mounts to the axle.
- h. Mount the control arm to the axle housing bracket. Install the original mounting bolt and finger tighten the nut. DO NOT torque mounting hardware until instructed. [20]



- i. Mount the control arm to the frame rail bracket so the grease fitting is up on the flex eye. Install the original mounting bolt and nut. Finger tighten the bolt.

HINT: If mounting bolt is difficult to install due to misalignment of Control Arm bushing with mounting bracket, either ⁽¹⁾ adjust height of axle housing with hydraulic jack, ⁽²⁾ move axle housing into position with a heavy-duty ratchet strap, or ⁽³⁾ temporarily disconnect track bar until mounting holes align.

- j. Repeat installation steps on opposite side of vehicle, then continue on to upper arms.
- k. Remove the electrical clip from the suspension arm clevis bracket if equipped.
- l. Remove the upper suspension arm nut and bolt from the axle housing bracket. Retain the original mounting hardware.
- m. Remove the upper suspension arm nut and bolt from the chassis rail bracket. Retain original mounting hardware. See specific year notes below.
- n. 2007-2011 models with 3.8L engine: To remove the passenger side bolt from the chassis, it will be necessary to raise the engine according to the followign instructions:
 - Position a second hydraulic jack beneath mounting flange of oil pan. support engine using a suitable block of wood (2x4 or larger) to distribute weight across oil pan bolts. DO NOT attempt to lift engine by engine oil pan.
 - Carefully raise the hydraulic jack just enough to remove the weight of the engine from the engine mounts. Locate the passenger side engine mount bracket and remove the four (4) bolts that secure it to the engine block. [21]

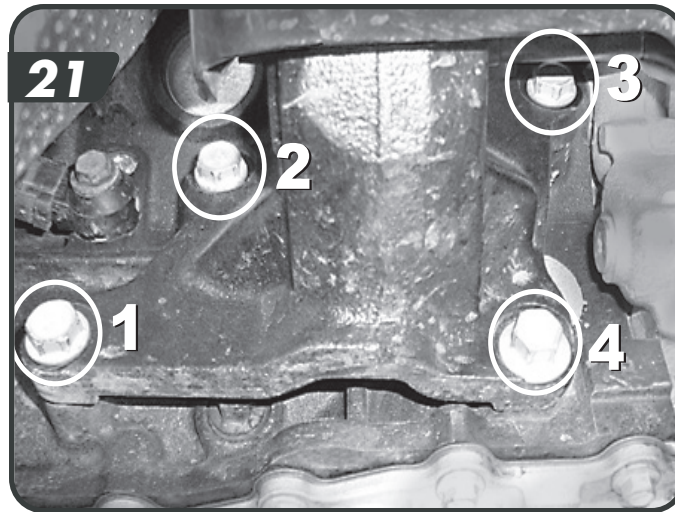

- Slowly raise the hydraulic jack approximately 1-2 inches until the passenger side control arm bolt clears the interfering exhaust pipe.
- Continue following instructions with engine in raised position and begin control arm install.
- o. 2012+ models with 3.6L engines: To access the frame bolts, it will be necessary to remove the heat shields from both the upper control arm frame mounts.
 - Remove the 2 bolts per heat shield, one on top and one on the bottom using a 10mm ratchet wrench. [22]



- p. Remove the original upper suspension arm from the vehicle.
- q. Set the lower control arm length.
 - Determine the ideal arm length for your application by considering factors such as:
 - Pinion Angle / Caster
 - Tire / Steering Clearance
 - Factory length is 18-3/4"
 - Max. length is 20-1/4"
 - Set both control arms to the same length. Lengthening the arms will reduce caster and increase pinion angle.
- r. Apply anti-seize lubricant to bolt threads of original mounting hardware.
- s. Mount the fixed end of adjustable control arm to the axle housing bracket. [23]



- t. Mount the flex end of the adjustable control arm to the chassis bracket with the greaseable fitting facing down.
- u. Install the original mounting bolt from inboard side. Bolt threads should point outboard.
- v. 2007-2011 models with 3.8L engine: Passenger side bolt must be installed with engine in the raised position to provide sufficient clearance around exhaust pipe.
 - With the control arm positioned in the chassis bracket, insert the original bolt into the mounting hole.
 - Carefully lower the hydraulic jack until the passenger side engine mount support bracket is realigned with the engine block.
 - Install the four (4) original bolts into the corresponding mounting holes and tighten to 45 ft-lbs using a torque wrench.
 - Lower the hydraulic jack and remove block of wood from beneath engine oil pan.
- w. Install the original mounting nut and finger tighten. **DO NOT** torque mounting hardware until instructed.
- x. Install the original mounting bolt from inboard side. **Bolt threads should point outboard.**
- y. Once both upper control arms have been installed, torque the frame mount hardware to 75 ft-lbs. (Upper control arms only at this time)
- z. 2012+ models: re-install the heat shields that were removed from the control arm mounts

FRONT BUMP STOP AND COIL SPRING INSTALLATION

Front bump stops 03178 will require bolt pack J107

- aa. Make a mark in the center of the lower coil spring mound pad. Drill a 5/16" hole at the mark. Using the provided 3/8" x 1" self tapping bolt (9/16"), tap a hole and remove the bolt. This hole will be used to attached the bump stop extension when the coils are installed. [24]



- ab. Place the provided bump stop extension inside one of the JSPEC front coil springs. Note: Taller springs are for the front. Install the front coil springs with the bump stop extension. Make sure the spring is seated properly in the axle mount.

Note: This kit includes an adjustable front bump stop system that allows for bump stop height to be tuned specifically for your wheel and tire combination. The system consists of one 2" bump stop block and two ½" bump stop blocks. [25] The 2" configuration is a good starting point for the recommended tire sizes

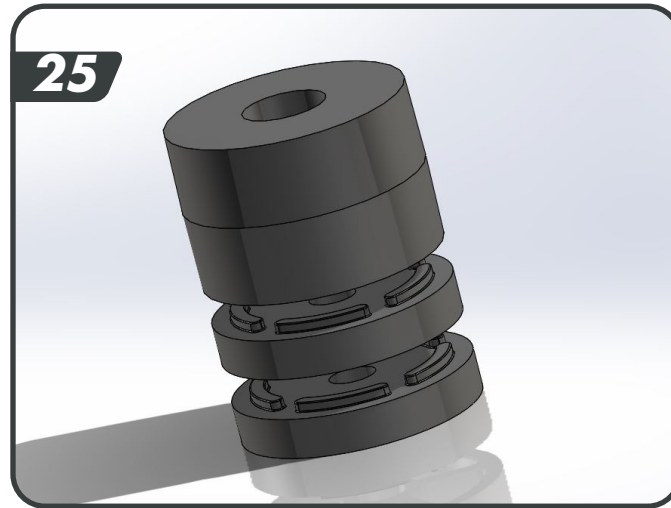

- ac. Attach the bump stop extension to the axle through the hole that was made earlier using the correct length 3/8" bolt and washer from bolt pack 150. Torque to approximately 25 ft-lbs.
- ad. Repeat the spring and bump stop installation on the other side of the vehicle.
- ae. Install the new shocks with the factory lower hardware and the new upper bushings and hardware. Torque the lower bolt to 60 ft-lbs and the upper nut until the bushings begin to swell.

QUICKER DISCONNECT INSTALLATION

NON-RUBICON MODELS

- af. Remove the nut and mount the longer tapered mounting posts on the outboard side of the sway bar ensuring the click pin holes are parallel with the ground. Slide the polyurethane spacer on the pin and up against the sway bar. Apply Loctite to the tip of the mounting post and fasten with the ½" nylock nut, tighten to 65 ft-lbs. [26]



Note: A small screwdriver or punch inserted into the pin hole will keep the post from turning as you tighten it.

- ag. Remove the nut and install the lower mounting posts into the factory sway bar link holes so they are pointing inboard and the pin holes are parallel to the ground. The passenger side post is squared off to provide clearance between the post and the OE track bar bracket. [27]



Note: In some cases a rotary grinder may be necessary to slightly open up the sway bar hole to clear the 1/2" bolt. This ensures a tight fit.

- ah. Apply Loctite to the tip of the mounting post and fasten with the 1/2" nylock nut and tighten to 65 ft-lbs.
ai. Adjust the length of the quicker disconnects to 9" center to center. This is a starting point and can be fine tuned once the vehicle is on the ground.
aj. Slide the upper and lower ends of the disconnects over the mounting posts. Insert click pins to secure. [28]

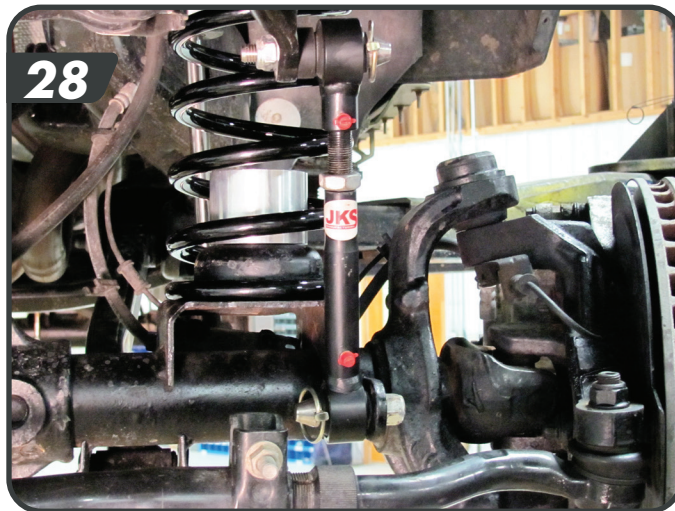

RUBICON MODELS

Rubicon models have a factory electronic disconnect system. Follow these steps to solid mount your sway bar links.

Fixed sway bar link mounting will require bolt pack J105

- ak. Adjust the length of the quicker disconnects to 9" center to center. This is a starting point and can be fine tuned once the vehicle is on the ground.
al. Locate the 3/4" x 1-1/4" sleeve and insert them into the lower bushing of the sway bar link. Insert the longer sleeves into the upper bushing. Slide the polyurethane spacer onto the upper sleeve so it will mount to the swaybar.
am. Using the 1/2" x 2-1/4" bolts, nuts, and washers fasten the links to the axle.
an. Using the 1/2" x 3" hardware, fasten the sway bar links to the sway bar.

Note: It may be necessary to slightly enlarge the sway bar hole using a rotary grinder or file to clear the 1/2" bolt.

- ao. Torque 1/2" hardware to 65 ft-lbs.

FRONT BRAKE LINE BRACKETS

Brake line brackets 03174 and 03175 require bolt pack 768
16 | JSPEC2354

- ap. The front brake line brackets have a tab that inserts into the OE frame slot with the bracket towards the rear of the slot. Attach the drop brackets to the brake line so the brake line tab fits into the drop bracket slot using the provided 1/4" hardware. [29]



- aq. Attach the brackets to the frame as shown using the factory hardware. You will need to slightly reform the hard lines.
- ar. Verify the newly formed hard lines are not rubbing on the frame or shock mount.
- as. Slightly reform the 90 degree bend in the OE brake line down 10-15 degrees by hand to provide additional slack if necessary.
- at. 2011-18 models: Reattach the brakelines below the coil spring mount with the factory bolt.

FRONT ADJUSTABLE TRACK BAR

- au. Adjust the length of the track bar to 32-3/4". This is a starting point, final adjustment can be made once the vehicle is on the ground.
- av. Insert the non adjustable end of the track bar into the frame mount with the clearance bend forward. Use factory hardware.

06. FINAL FRONT INSTALLATION STEPS

- a. 2012-18 models, install the exhaust extensions using the instructions provided in the JKS8150 kit, sold separately.
- b. Rubicon models: Reattach the locker wire harness to the differential.
- c. Reattach the front driveshaft to the axle flange. Use Loctite on the bolts. Torque to 81 ft-lbs.
- d. Install the wheels and torque to the lug nuts to 125 ft-lbs.
- e. Lower the vehicle to the ground and bounce the vehicle to settle the suspension. Torque the front lower control arm bolts at the axle and at the frame to 125 ft-lbs. Torque the front upper control arm bolts at the axle to 75 ft-lbs. Torque the rear lower control arm and upper control arm hardware to 125 ft-lbs.
- f. Tighten the control arm jam nuts using JKS1696 or equivalent.
- g. Grease the flex end bushings.
- h. Attach the front track bar to the axle with the OE hardware. Have an assistance turn the steering wheel to aid in aligning the track bar bolt. Take measurements to check if the axle is centered. Make an adjustment to the track bar equal to half of the distance the axle is shifted to one side. Torque the frame and axle track bar bolts to 125 ft-lbs.

07. MAINTENANCE

- a. Control arm flex ends should be greased regularly as part of vehicle maintenance or after every 4-wheeling trip. Lubricate using marine grade grease. Rubber bushings require no maintenance.

08. STICKER INSTALLATION

Sticker installation should be performed when the temperature is above 60° F.



- a. Clean the areas thoroughly with rubbing alcohol to remove any buildup.
- b. Carefully place the sticker in the desired location.
- c. Rub gently to secure, then press firmly for 30 seconds.

KIT CONTENTS

JSPEC2251 COIL SPRINGS - 2.5" 2 DOOR

Part No.	Qty	Description
034213R	2	Front coil springs - 2 Door
034217R	2	Front coil springs - 2 Door

JSPEC2250 COIL SPRINGS - 2.5" 4 DOOR

Part No.	Qty	Description
034210R	2	Front coil springs - 4 Door
034218R	2	Rear coil springs - 4 Door

JSPEC2351 COIL SPRINGS - 3.5" 2 DOOR

Part No.	Qty	Description
034313R	2	Front coil springs - 2 Door
034317R	2	Front coil springs - 2 Door

JSPEC2350 COIL SPRINGS - 3.5" 4 DOOR

Part No.	Qty	Description
034310R	2	Front coil springs - 4 Door
034318R	2	Rear coil springs - 4 Door

JSPEC2354 MAIN BOX KIT

Rear Track Bar Bracket

Part No.	Qty	Description
03179	1	Rear track bar bracket
03217	1	Riser Brace Tab
123250500R	1	1/2" x 3-1/4" x 5" U-bolt
J103	1	Bolt pack - Rear track bar bracket
	2	1/2" nylock nut
	2	1/2" SAE washer
	2	3/8" x 1" bolt
	4	3/8" SAE washer
	2	3/8" prevailing torque nut
	1	9/16" x 3" bolt
	1	9/16"-12 lock nut
	2	9/16" SAE washer

JSPEC2354 MAIN BOX KIT (CONT.)

Brake Line Brackets

Part No.	Qty	Description
03174	1	Front brake line bracket - Drv
03175	1	Front brake line bracket - Pass
03172	1	Rear brake line bracket - Drv
03173	1	Rear brakeline bracket - Pass
768	2	Bolt Pack - Front brake line brackets
	2	1/4"-20 x 3/4" bolt
	2	1/4"-20 nylock nut
	4	1/4" USS washer

Front Adjustable Track Bar

Part No.	Qty	Description
03044	1	Trackbar
03045	1	Adjusting Shaft Assembly
36274	1	1-1/4" Jam Nut
MB01B701740	2	Bushing

Quicker Sway Bar Disconnects

Part No.	Qty	Description
03005	2	Quick Pin
M03212-BK-01	2	Offset Polyurethane Spacer
A1046	2	Stainless Steel Post w/ Nut - Upper
A1044	1	Stainless Steel Post w/ Nut - Pass
Lower		
A1045	1	Stainless Steel Post w/ Nut - Drv Lower
03010	2	Sway Bar Link - Female
03011	2	Sway Bar Link - Male
M00475-BK-01	4	Spherical Bushing
7050R	4	Grease Zerk Cap
7607	4	Grease Zerk
36264	2	5/8" Jam Nut

JSPEC2354 MAIN BOX KIT (CONT.)

Bump Stop Extensions

Part No.	Qty	Description
3296-STN	2	2" Front bump stop spacer
3596	4	0.5" Front bump stop spacer
J150	1	Bolt Pack - Front bump stops
	2	3/8"-16 x 2-1/2" bolt
	2	3/8"-16 x 3" bolt
	2	3/8"-16 x 3-1/2" bolt
	2	3/8" USS washer
	2	3/8" flange lock nut
32425	1	3/8" x 1" self-tapping bolt
03574	1	Drv Rear bump stop spacer
03575	1	Pass Rear bump stop spacer
J106	1	Bolt Pack - Rear bump stops
	4	5/16" x 3/4" bolt
	4	5/16" prevailing torque nut
	8	5/16" SAE washer

Rubicon Fixed Mount Hardware

Part No.	Qty	Description
66	2	3/4" X 1.65" Sleeve
144	2	3/4" x 1.25" Sleeve
J105	1	Bolt Pack - Fixed Links
	2	1/2"-13 x 3" Bolt
	2	1/2"-13 x 2-1/4" Bolt
	4	1/2" Washer
	4	12mm Flat Washer
	2	1/2" Lock Nut

J-FLEX CONTROL ARMS

Part No.	Qty	Description
A1018	2	J-Flex Front Lower Control Arm
A1016	2	J-Flex Front Upper Control Arm
A1019	2	J-Flex Rear Upper Control Arm
A1017	2	J-Flex Rear Lower Control Arm